

DAMOS
DISPOSAL AREA MONITORING SYSTEM
ANNUAL DATA REPORT - 1978

SUPPLEMENT A
ROCKLAND DISPOSAL SITE

Naval Underwater Systems Center
Newport, Rhode Island



New England Division
Corps of Engineers
Waltham, Massachusetts

May 1979

DAMOS

DISPOSAL AREA MONITORING SYSTEM
ANNUAL DATA REPORT - 1978

SUPPLEMENT A
SITE REPORT - ROCKLAND

Naval Underwater Systems Center
Newport, Rhode Island

New England Division
Corps of Engineers
Waltham, Massachusetts

May 1979

DISPOSAL AREA
MONITORING SYSTEM
SITE LOCATIONS

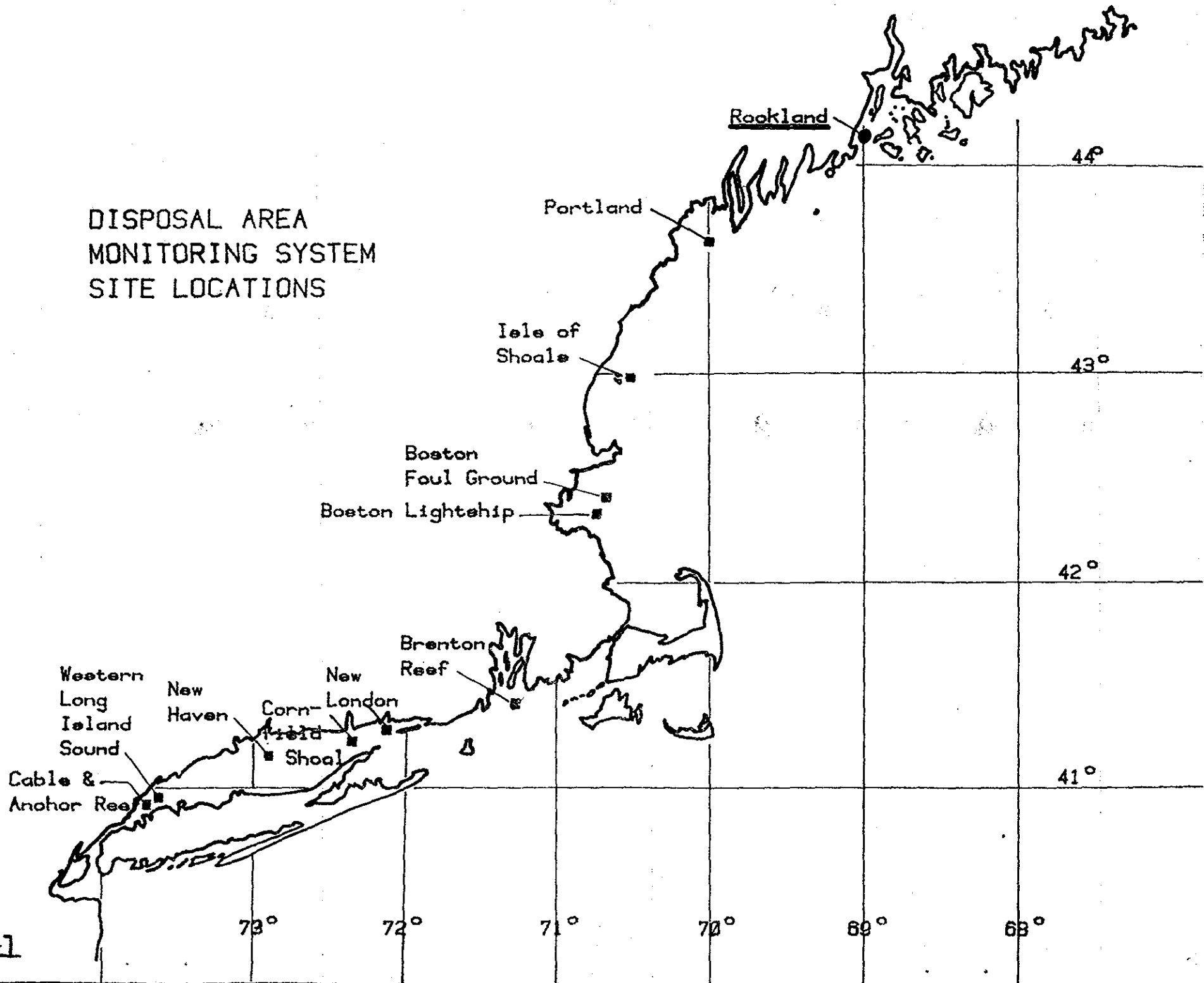

FIG.-1

DISPOSAL AREA MONITORING SYSTEM

This is one of a series of site specific data reports resulting from the DAMOS program, now two years in progress. DAMOS is the culmination of nearly a decade of prior study efforts, actually preceding NEPA, which have been directed towards the understanding of the effects of and the responsible management of the ocean disposal of dredged materials in New England waters as they fall under the authority of the New England Division of the Corps of Engineers. The individual site reports henceforth will be updated approximately on an annual bases as additional knowledge is gained, at least with respect to those sites where significant disposal activities will have occurred.

ROCKLAND

Background

The Rockland disposal site is located in the center of West Penobscot Bay three and one-half miles from the Rockland breakwater and three miles from North Haven Island (Fig. A-1).

The site was first used in October 1973-February 1974 for disposal of 68,850 cubic meters of material from Rockland Harbor. Disposal was at a buoy at 44° 07.5N and 69° 00.4W. Kyte (1974) studied the area before and immediately after its use. He found that the natural bottom was cohesive clay and silt and that the spoil was mostly clay with less organic matter and more chromium than the natural sediments. Some "odoriferous black organic silt" from the inner harbor was also sampled. Kyte concluded that "point dumping" had been successful since spoil formed a pile on the floor and sides of the deep hole running through the site and extended less than 450 meters north - south.

Bathymetry

Two bathymetric surveys of the Rockland disposal site have been made. Navigation control for these surveys was provided by trisponder stations located at Deadmans Point and Owls Head Light. The first survey on 11 December, 1977 (Figures A-2 (a-f)) covered a half mile square designated on the chart as the disposal site. The second survey on 12 May, 1978 (Figures A-3 (a-g)) was expanded 400 meters north and 200 meters east to provide better definition of the depression through the site.

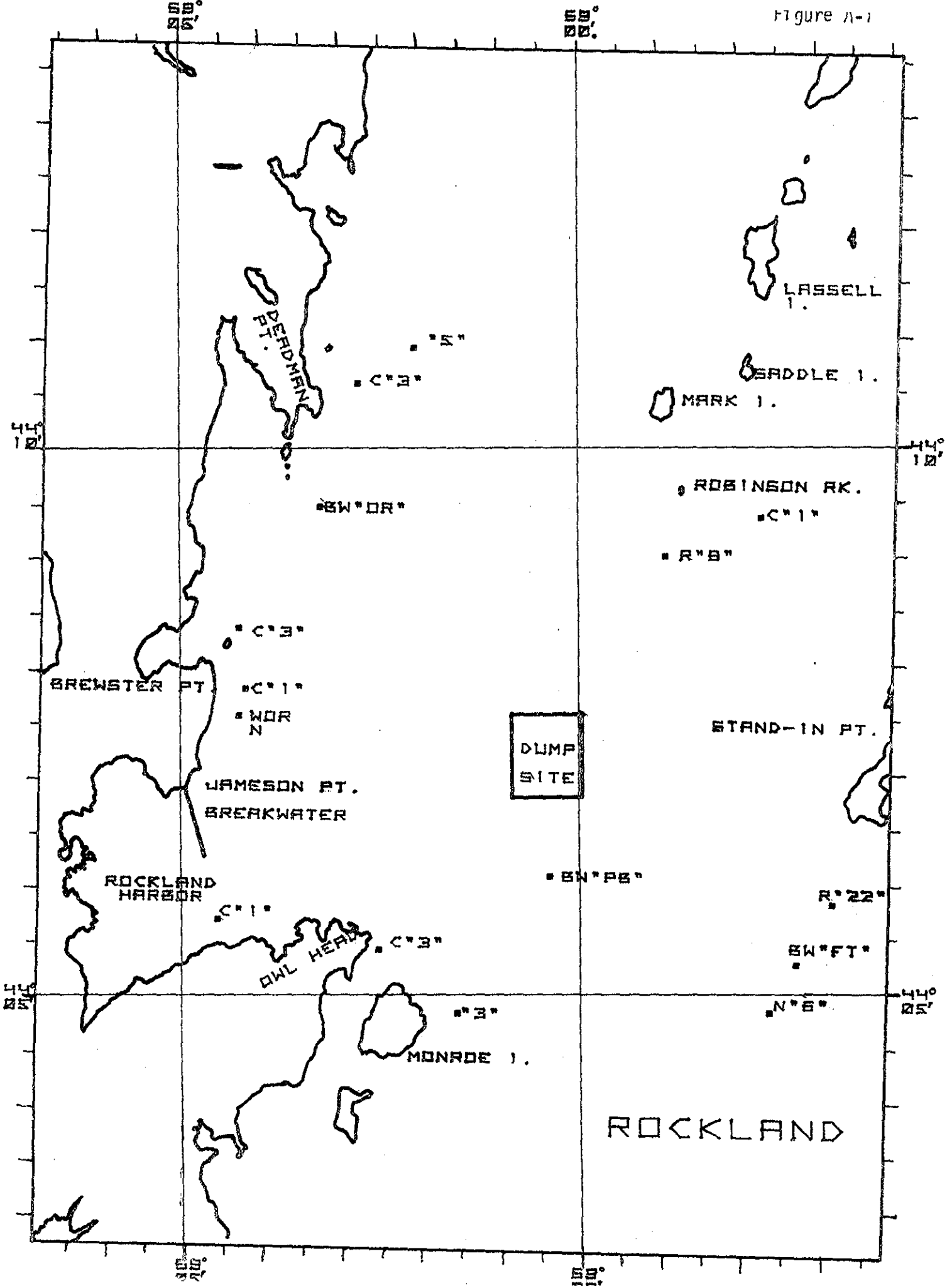

Figure A-2

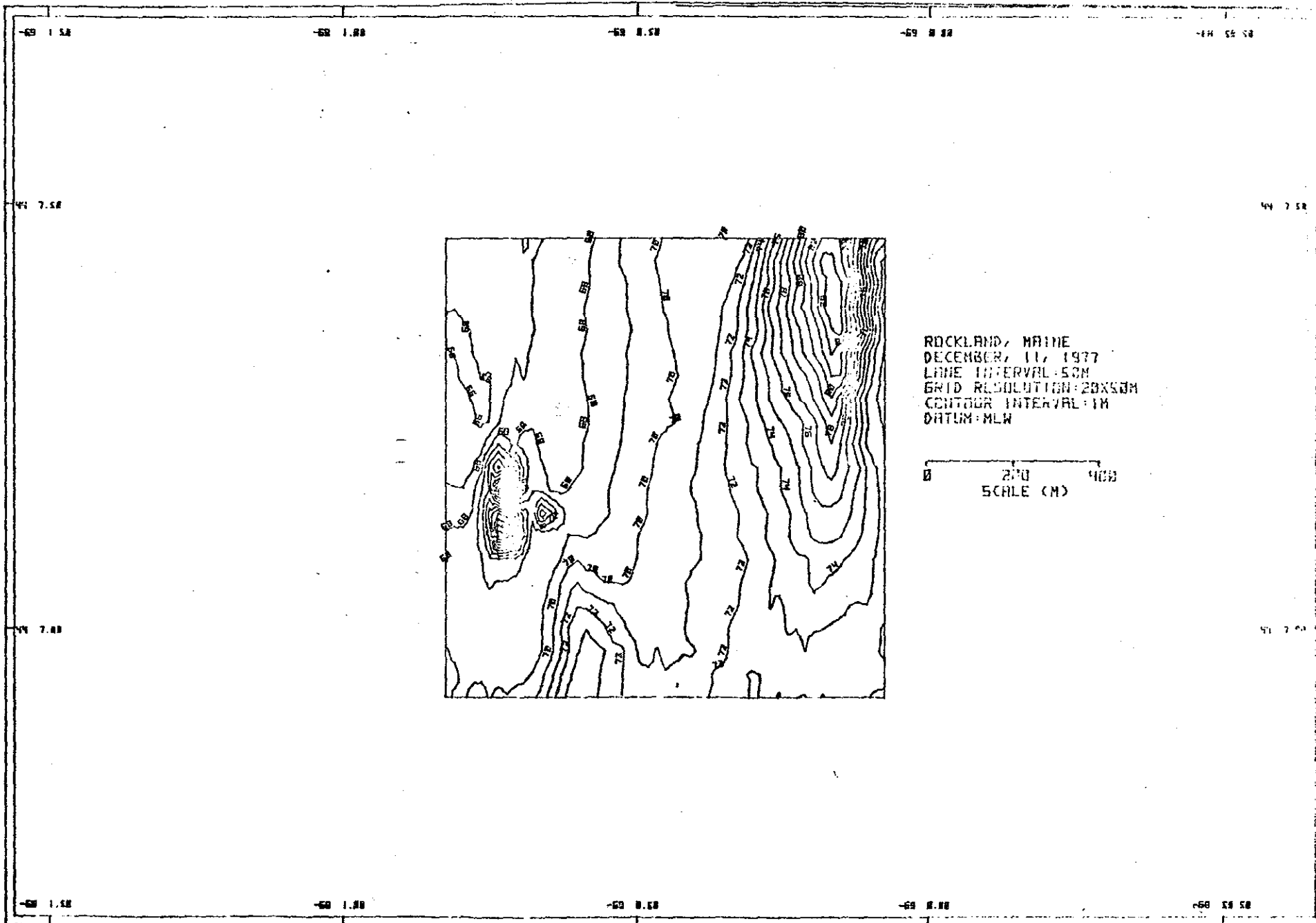

Figure A-2a

ROCKLAND, ME.
SURVEY DATE - 11 APR 77
VERTICAL EXAGGERATION - 5

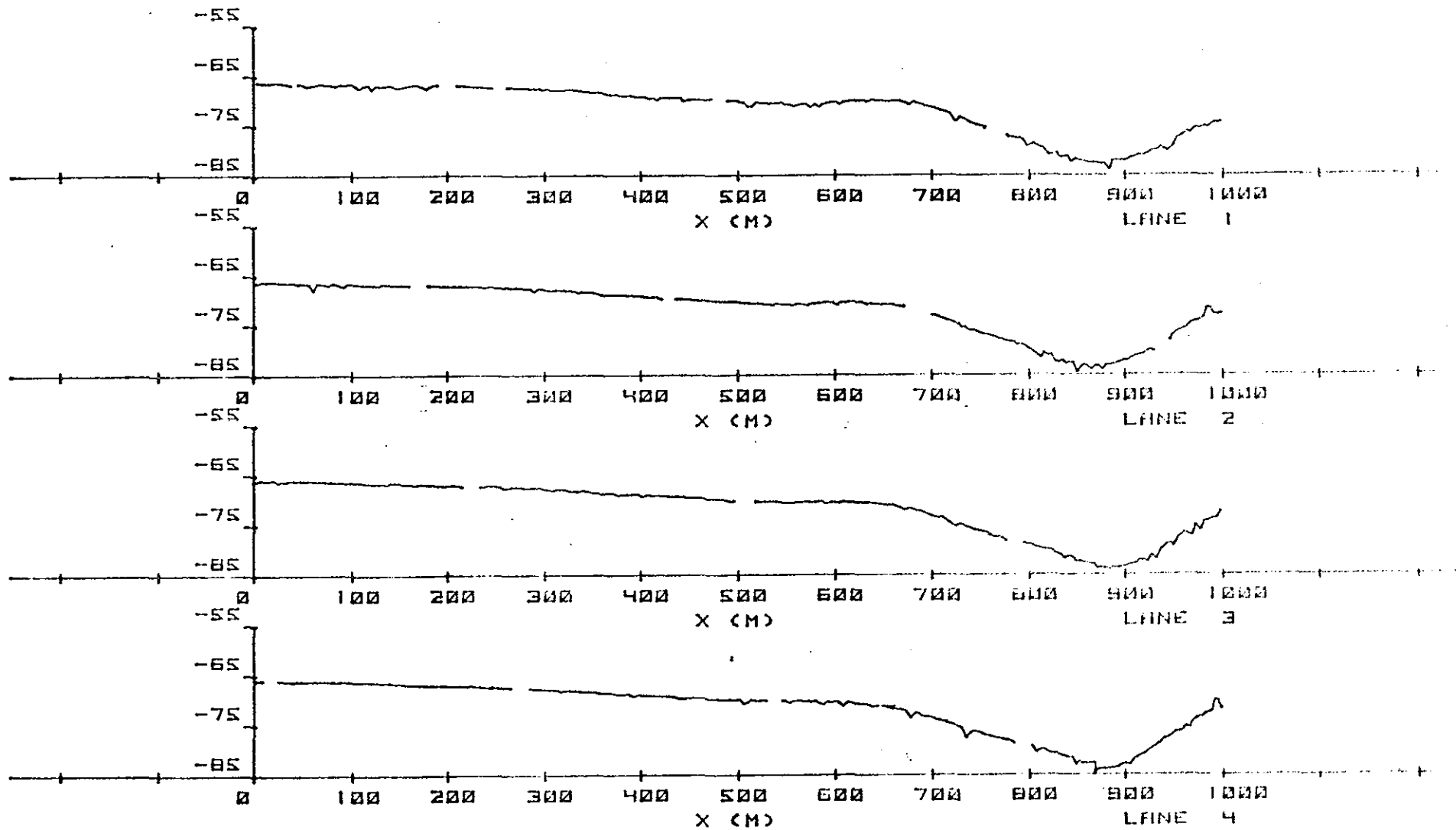

Figure A-2b

ROCKLAND, ME., 11 DEC 77 (CONT.)

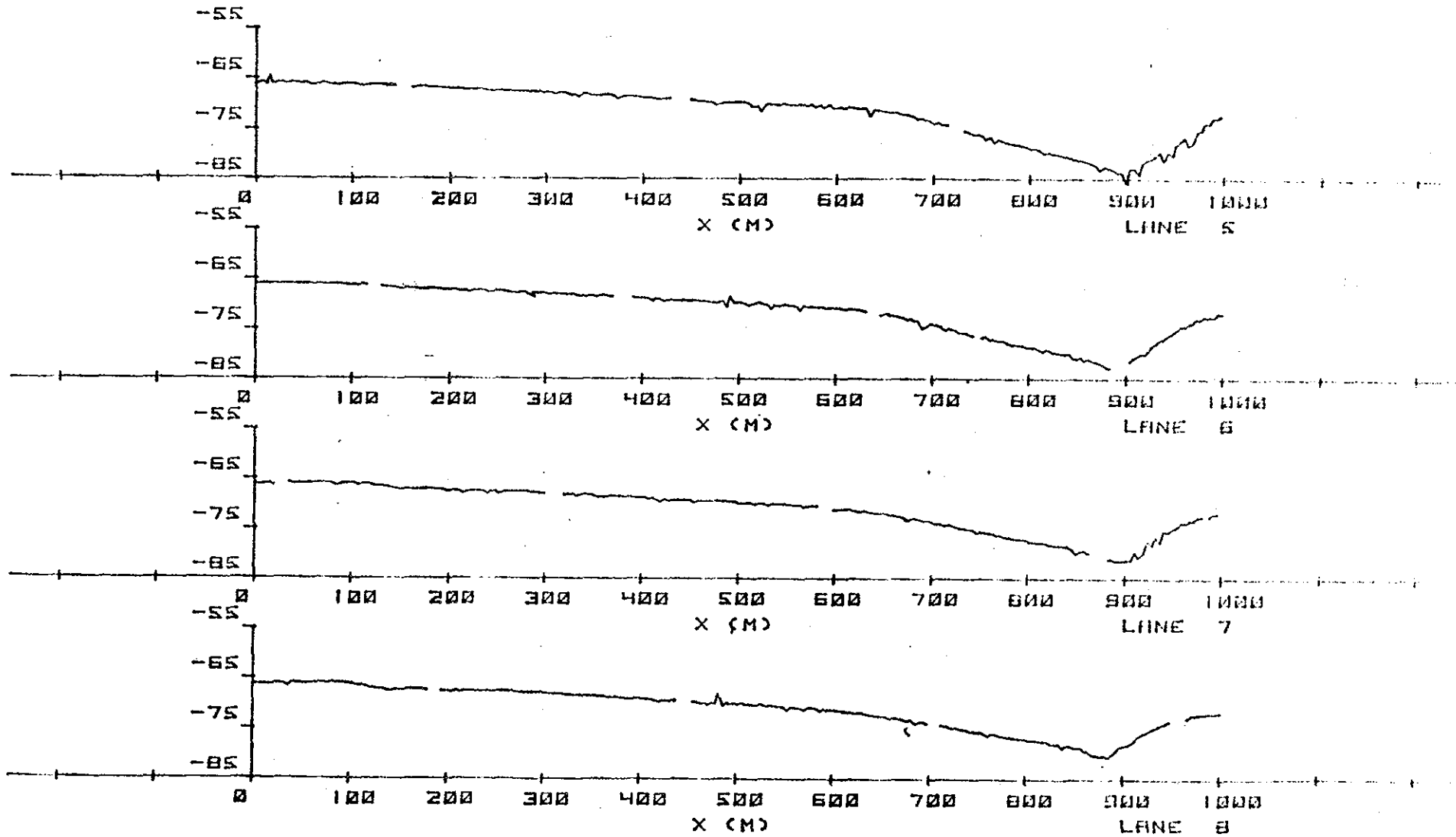

Figure A-2c

ROCKLAND, ME., 11 DEC 77 (CONT.)

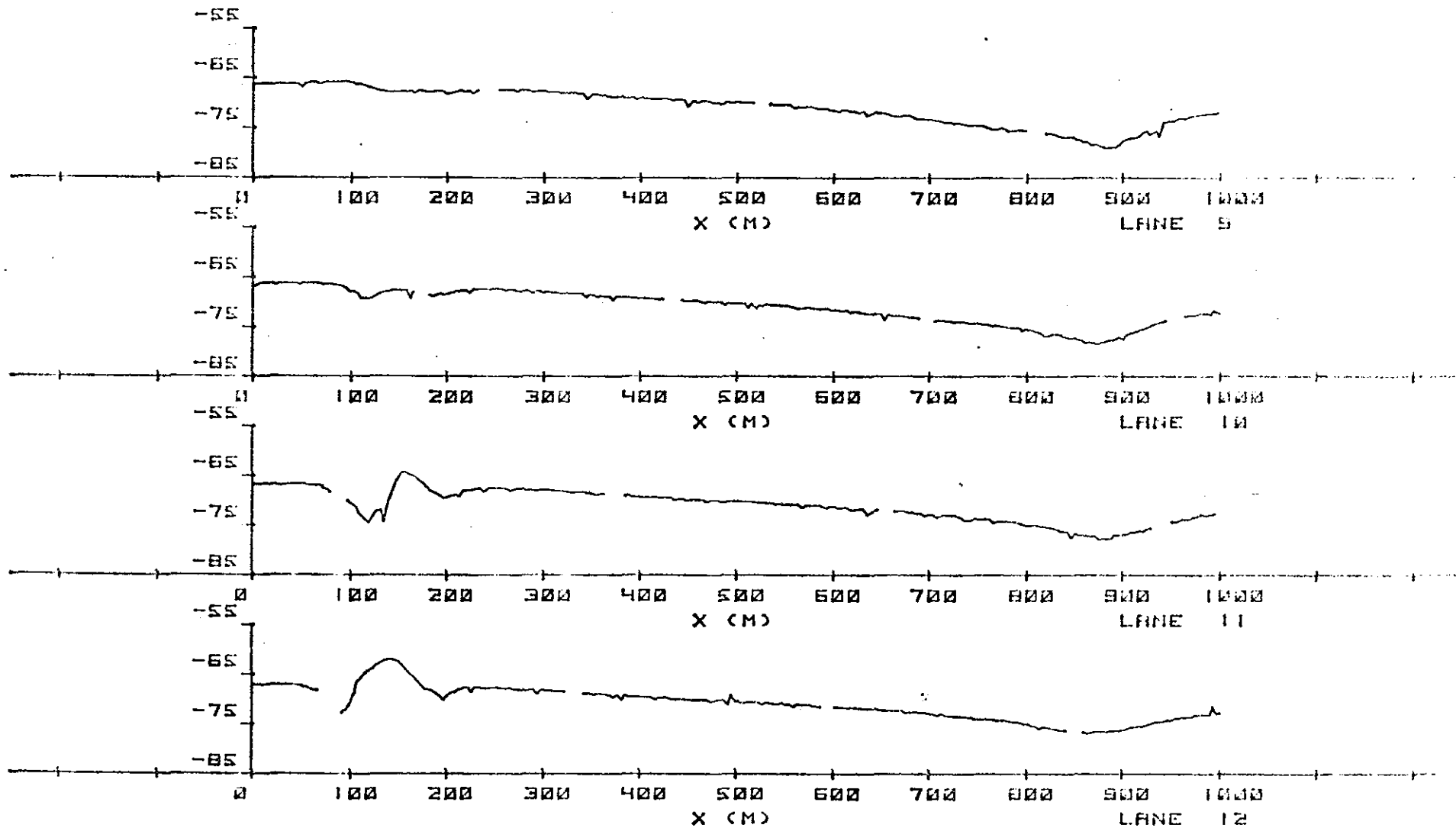

Figure A-2d

ROCKLAND, ME., 11 DEC 77 (CONT.)

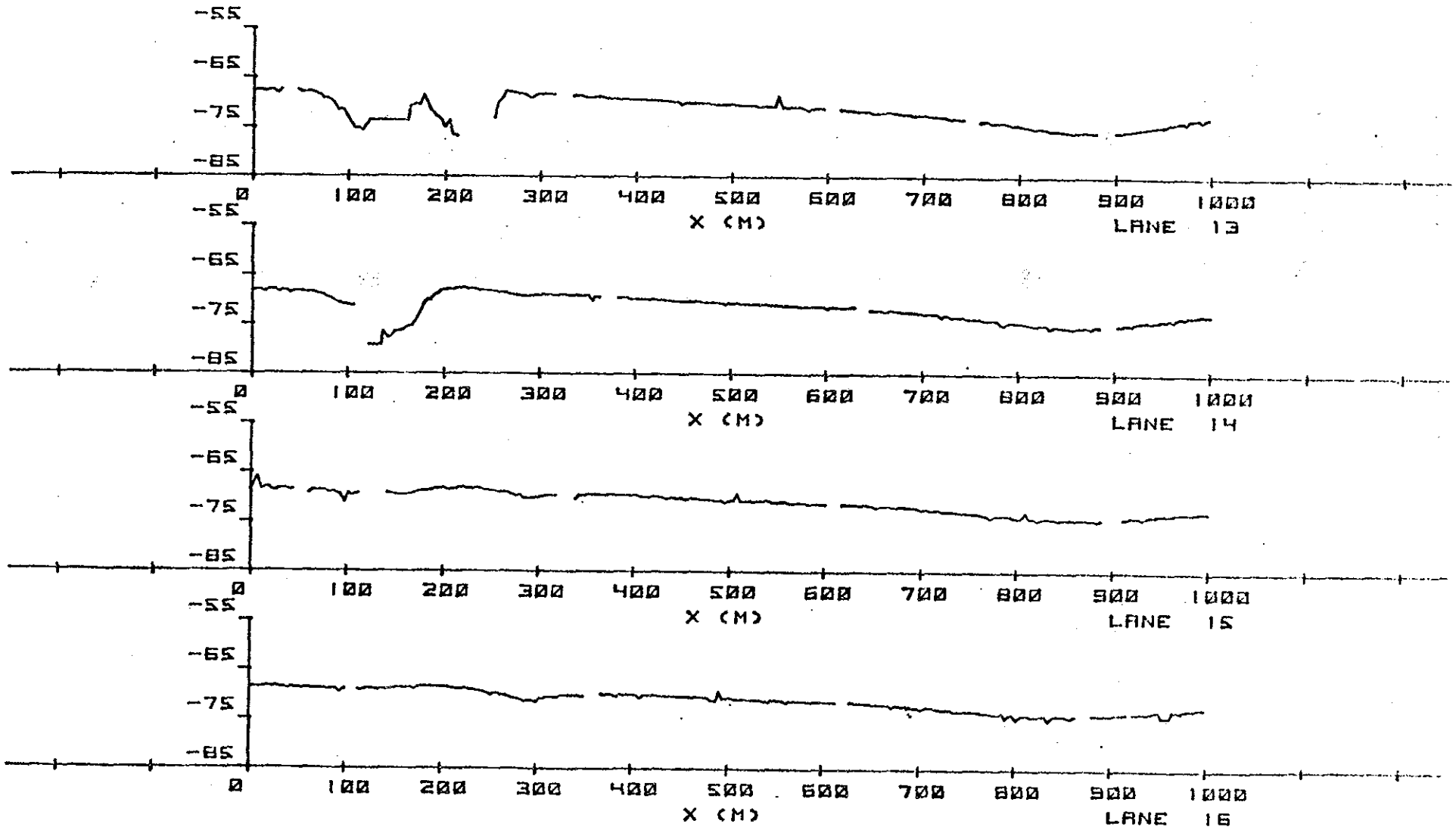

Figure A-2e

ROCKLAND, ME., 11 DEC 77 (CONT.)

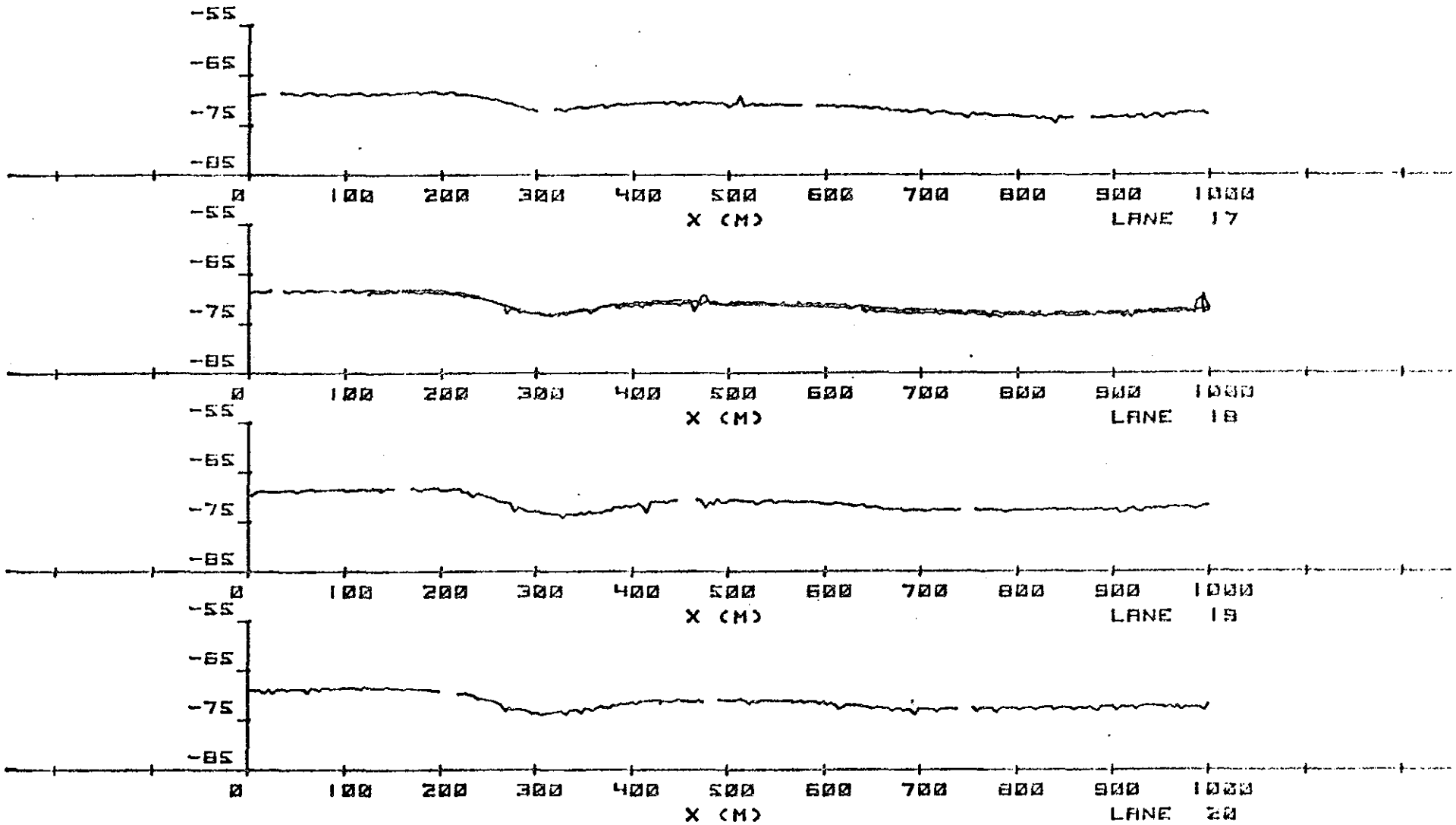

Figure A-2f

ROCKLAND, ME., 11 DEC 77 (CONT.)

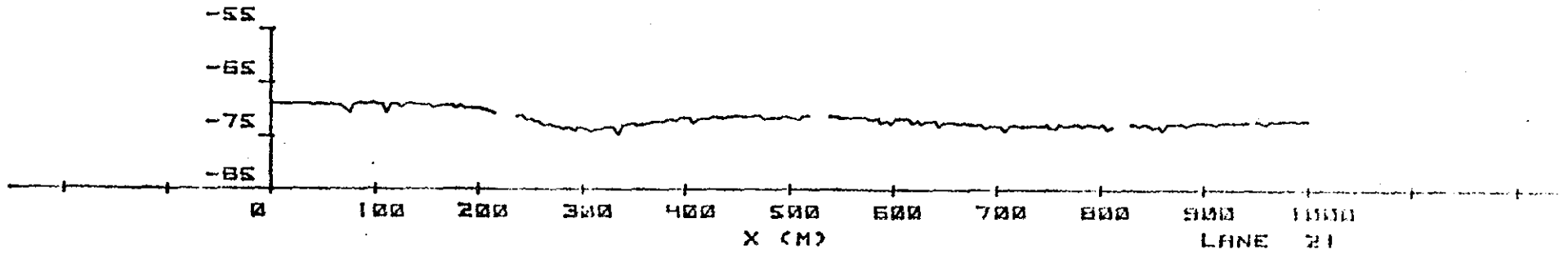

Figure A-3

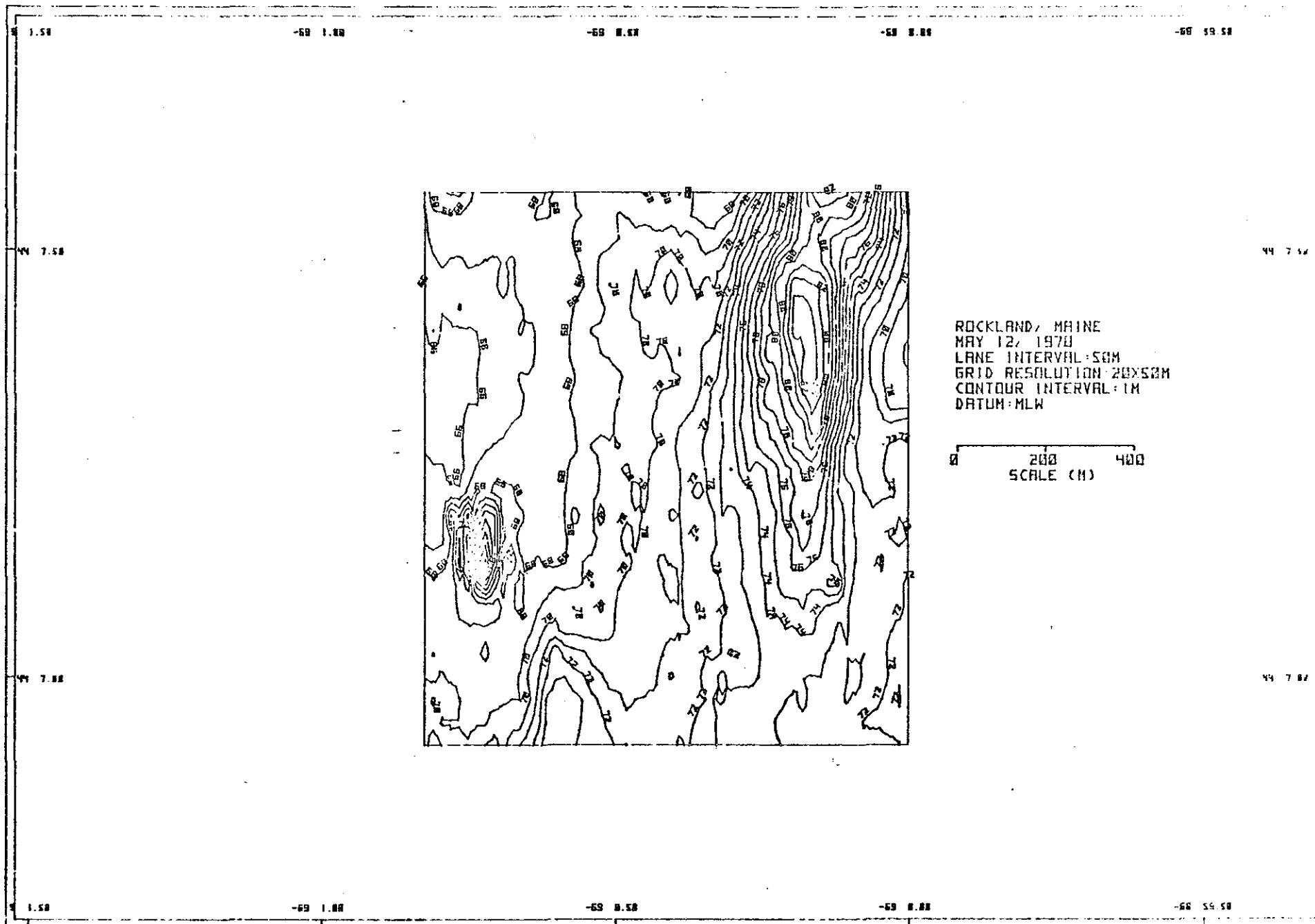

Figure A-3a

ROCKLAND, ME.
MAY 12, 1978
VERTICAL EXAGGERATION : 5X
LANE INTERVAL : 500

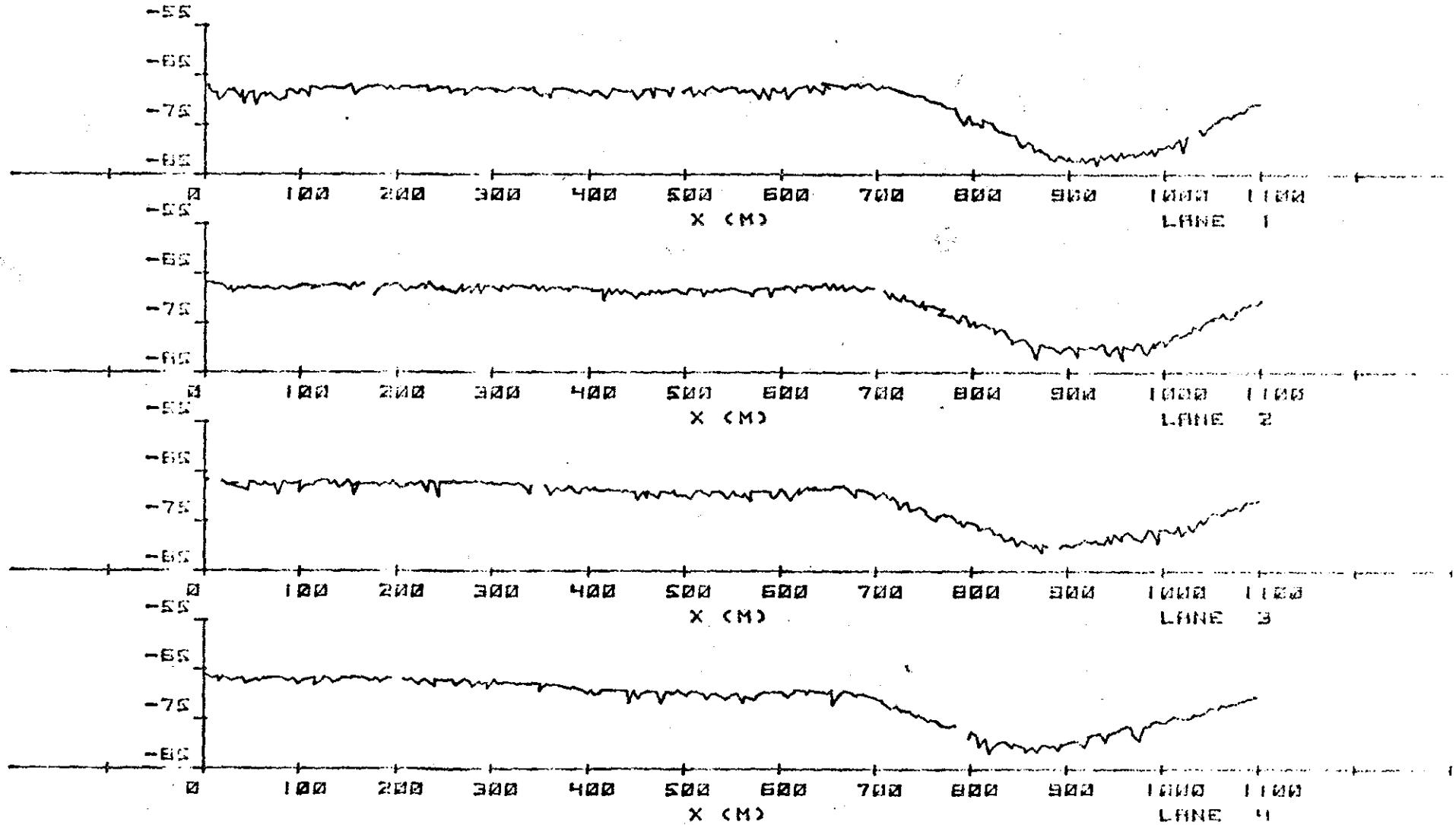

Figure A-3b

ROCKLAND, ME.
MAY 12, 1978
VERTICAL EXAGGERATION = 5X
LANE INTERVAL = 50M

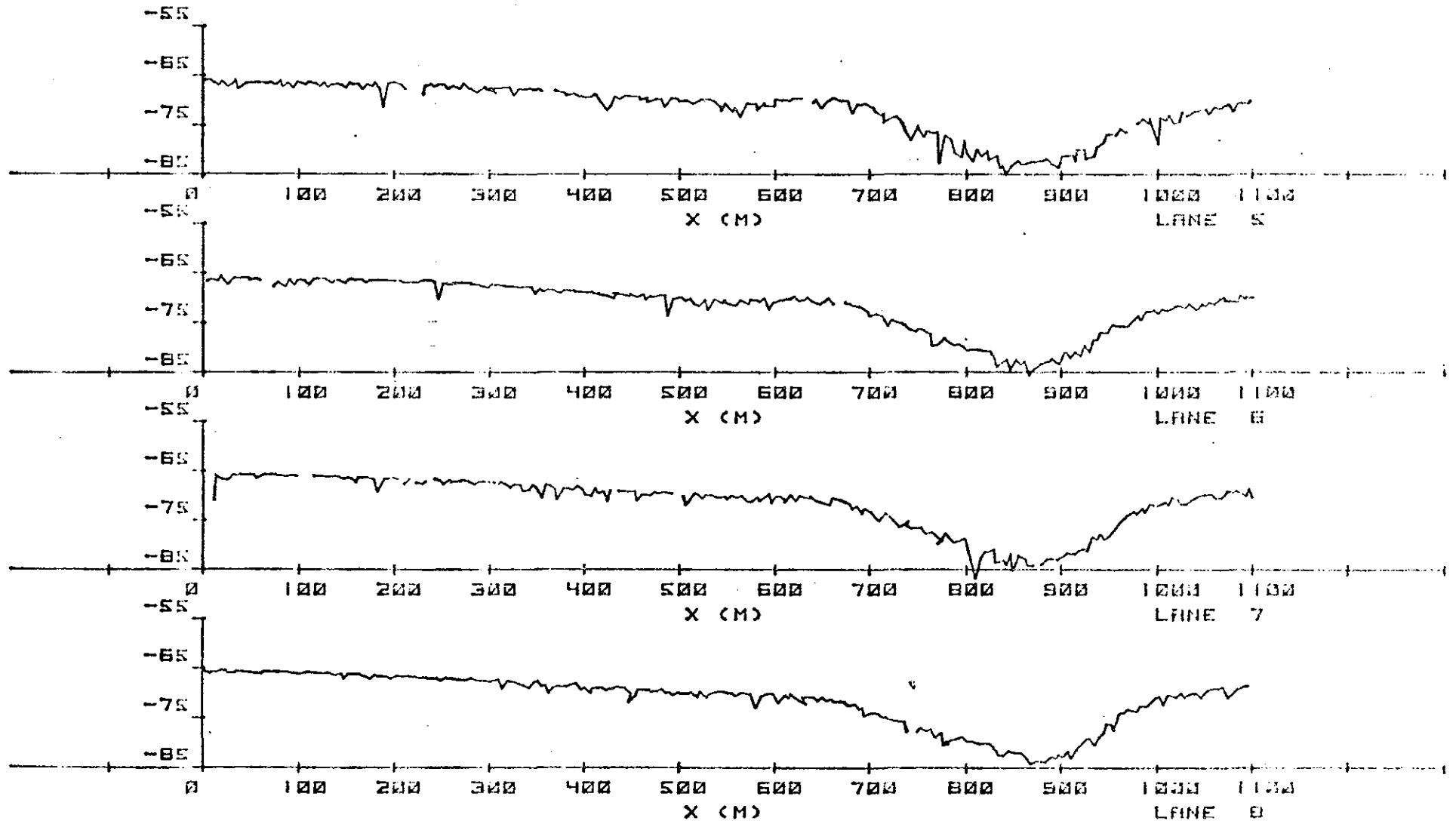
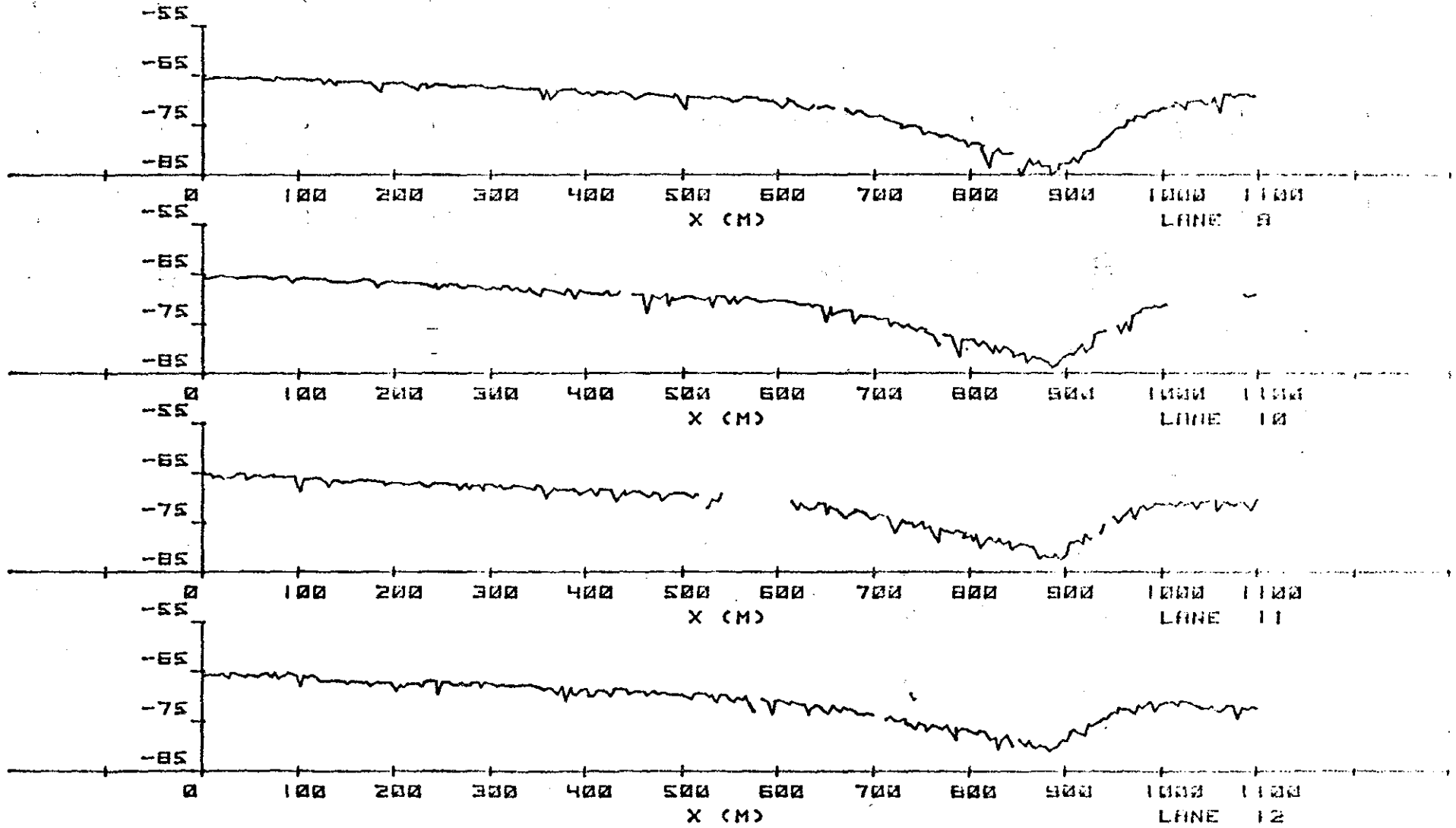

Figure A-3c

ROCKLAND, ME.
MAY 12, 1978
VERTICAL EXAGGERATION = 5X
LANE INTERVAL = 50M



ROCKLAND, ME.
MAY 12, 1978
VERTICAL EXAGGERATION : 5X
LANE INTERVAL : 50M

Figure A-3d

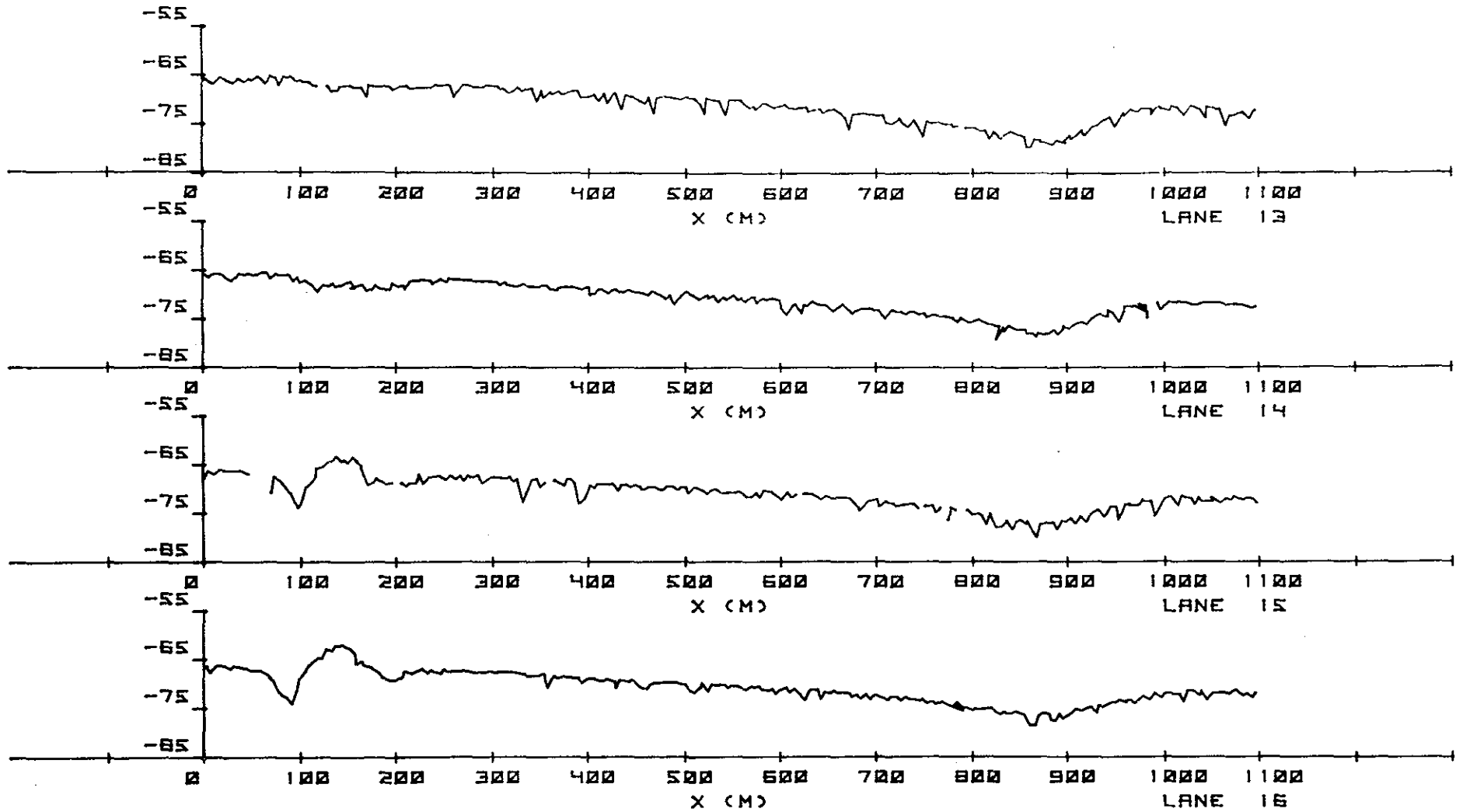

ROCKLAND, ME.
MAY 12, 1978
VERTICAL EXAGGERATION: 5X
LANE INTERVAL: 50M

Figure A-3e

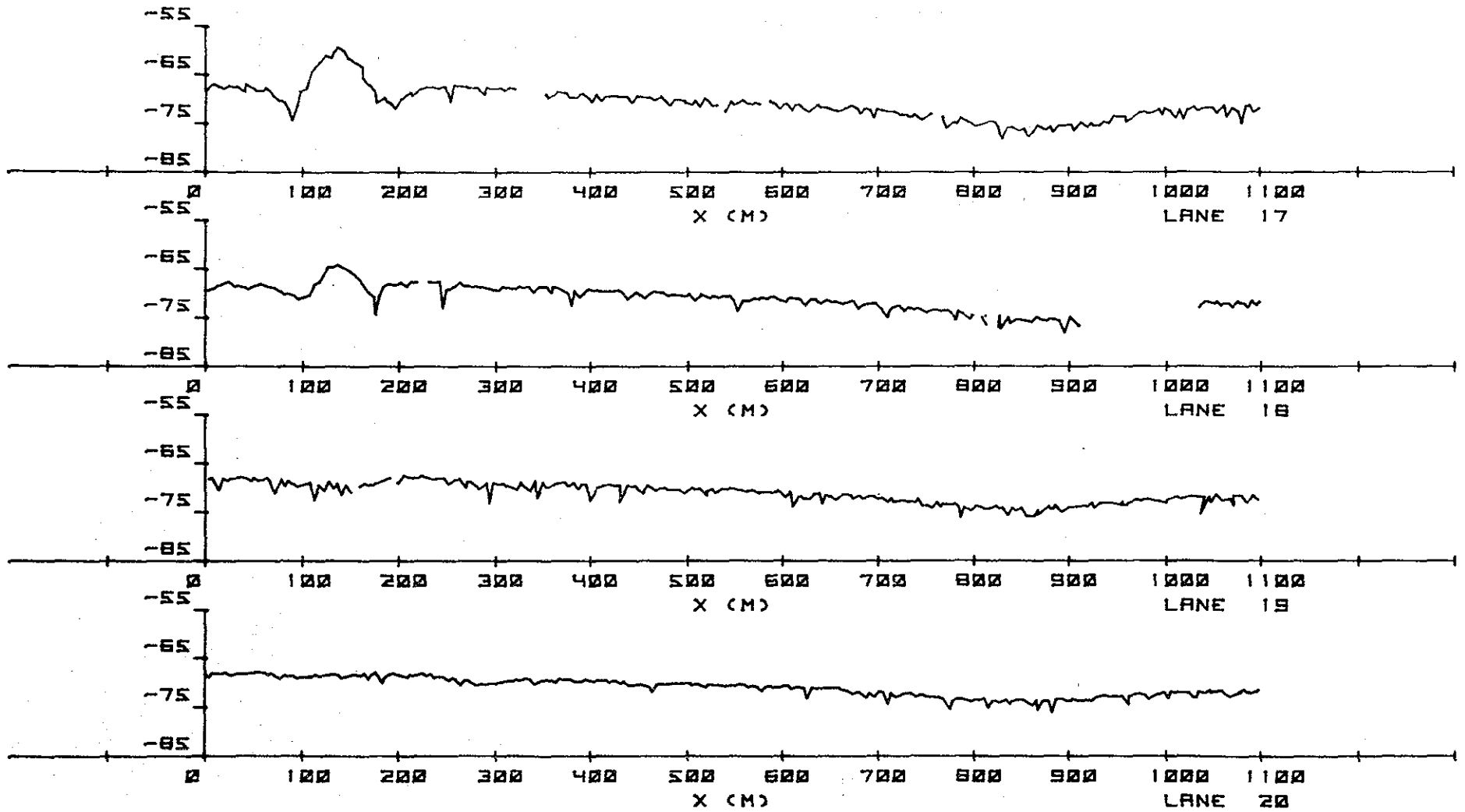

Figure A-3f

ROCKLAND, ME.
MAY 12, 1978
VERTICAL EXAGGERATION : 5X
LANE INTERVAL : 50M

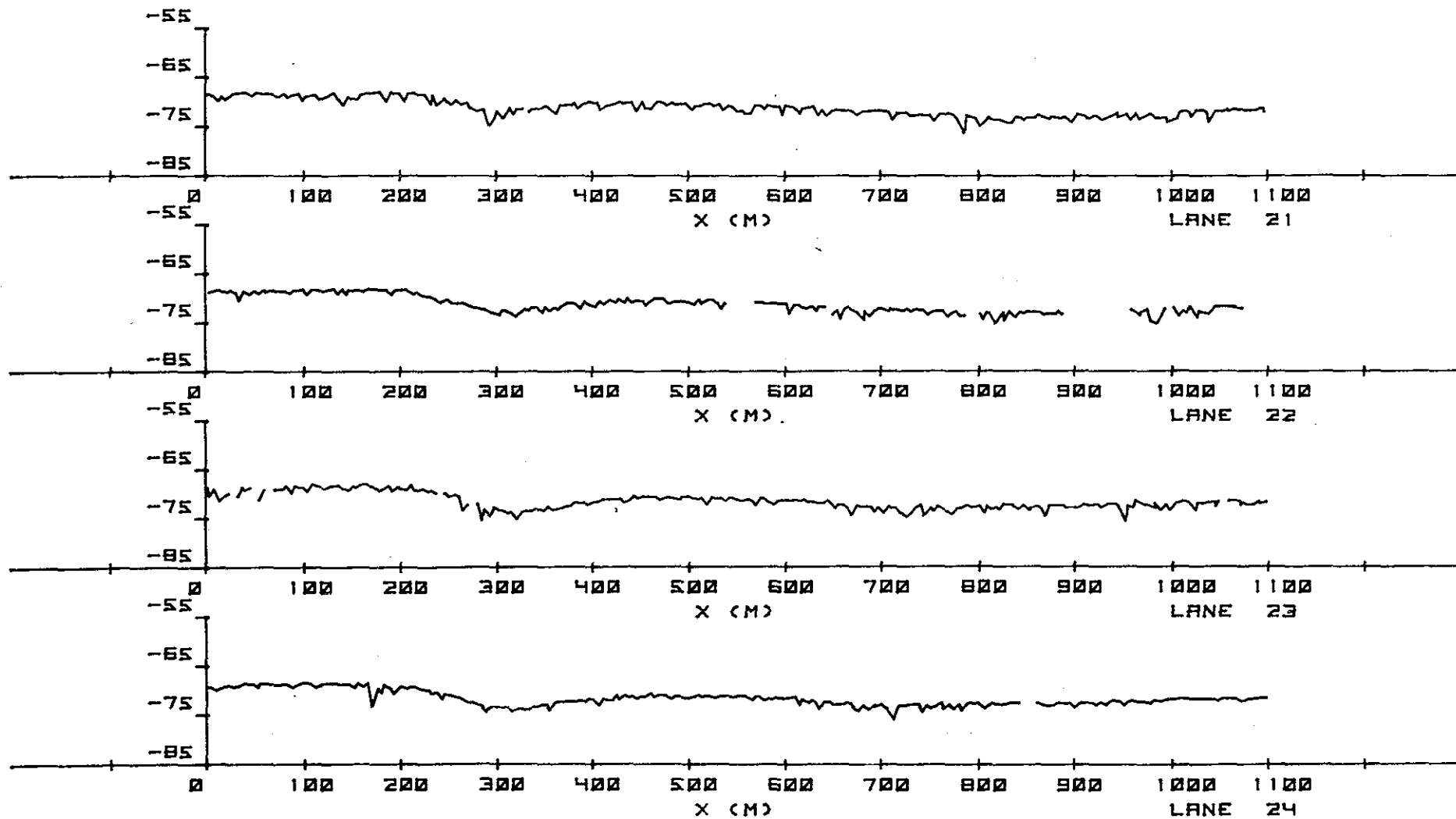
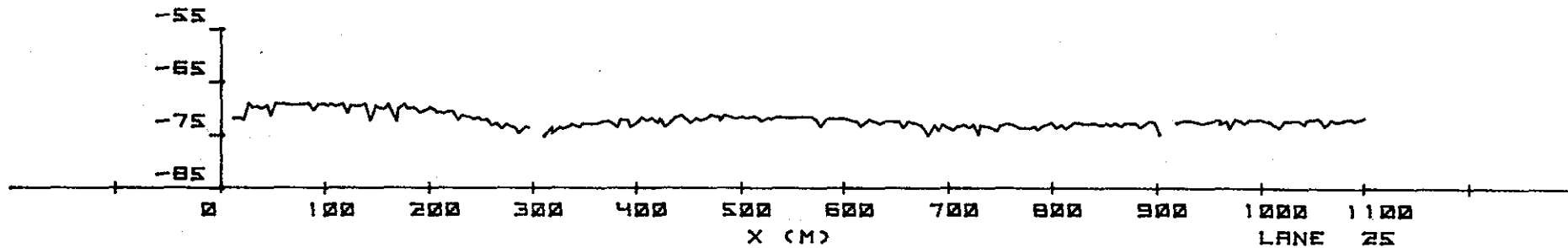

Figure A-3g

ROCKLAND, ME.
MAY 12, 1978
VERTICAL EXAGGERATION : 5X
LANE INTERVAL : -50M



Although these surveys show the depression described by Kyte there is no indication of a spoil pile present in the trough. The location of the disposal buoy would mean deposition of spoils east of the trough, and although there is no indication of a spoil mound in that area, sediment samples from that location have contained spoils, building materials, pipes etc. Another location where samples have indicated spoil disposal was found by Kyte south of the disposal site (Figure A-5). Further work to define the distribution of spoils in this site will continue since there is no obvious pile present at this time.

A large outcrop of bedrock, as verified by side scan sonar occurs in the southwest corner of the disposal site. This and the north-south trending trough are the only topographic features of significance in the disposal site.

Currents

No current measurements have been made in the vicinity of the Rockland disposal site.

Sediment

Sediments in the Rockland site are almost entirely composed of soft black mud overlying a basement of glacial material. Heavy metal analysis of samples taken from the Rockland area are presented in Table A-1. All five surface sediment samples taken from the dump site, reference location and harbor were metal enriched compared to cleaner areas such as Isle of

TABLE A-1a
SAMPLE LOCATIONS

SITE: Rockland, Me.

DATE	DISPOSAL SITE:				REFERENCE SITE		
	CURRENT METER	MUSSELS	BENTHIC SAMPLES		MUSSELS	BENTHIC SAMPLES	
			DREDGES	GRABS		DREDGES	GRABS
12/Dec/1977	44007'02.5" + 69000'18.2"		44007'15.5" 69000'08.3"				
11/May/1978			44008'06" 69000'30"				
13/May/1978		44007'18.2" 69000'05.1"		44007'40.3" 69000'03.6"	44006'12" 68057'15"		Rock. Harbo Can #1 NVN #4 ?
13/May/1978				44007'15.0" 69000'48.9"			
13/May/1978				44006'51.0" 69000'26.0"			
17/Nov/1978			3143 4054				

+ Lost

Rockland

• May '78 Dredge

May '78 Grab #1

May '78 Mussell Cage

Dec '77 Dredge

44° 07'

May '78 Grab #2

⊕ Dec '77 Current Meter

May '78 Grab #3

69° 00.5'

69° 00'

⊕ Current Meter

○ Mussell Cage

• Benthic Samples

TABLE A-1
 SURFACE SEDIMENT ANALYSIS
 ROCKLAND MAINE

SAMPLING	Cd	Co	Cr	Cu	Fe*	Hg	Ni	Pb	Zn	Vol/Sol (%)	Oil/Grease (ppm)x10 ³
	all metals ppm										
MAY 1978											
RH C1-N2 (harbor)	.44	16	56	39	.25*	.15	47	53	129	8.8	5.2
R Ref 1	.54	9.5	40	15	1.6	.17	28	30	71	18.6	5.5
R Ref 2	.44	17	51	21	.26	.037	49	16	60	5.5	nil
R Ref 3	.26	10	41	8.9	1.6	.12	28	22	58	15.2	2.3
Rd (dump)	.45	11	46	12	1.6	.11	33	28	69	12.1	2.4

* all Fe values multiply by 10⁴

Shoals or Brenton Reef, Rhode Island. The Rockland dump site has been inactive for several years, yet surface sediments are not greatly different from the two reference samples. The single harbor sample shows very low iron content and about the same metal composition as the dump and reference samples. A third reference sample taken near the dump site in Penobscot Bay resembles the harbor sample's composition.

Biochemical Studies

Table A-2 summarizes the heavy metal concentration of M. modiolus samples placed on the Rockland disposal site at 44° 07' 18.2" N, 69° 00' 05.1" W and from reference samples taken at Drunkards Ledge approximately 3 NM southeast of the disposal site. These data are presented for analysis in Figure A-4. The data indicate there are no significant differences between the concentrations of Cd, Cr, Cu or Hg either between the reference and disposal site stations or with time. However, the concentration of Pb in M. modiolus samples from Drunkards Ledge on May 12 and August 7, 1978 is significantly less than that of the baseline data. A similar significant reduction in the concentration of Fe is observed in the mussels sampled on August 7 from the reference site.

Benthic Macrofauna

As indicated by Table A-3 only two species comprise 95% of the species present at the Rockland site. Obviously more data are required before more extensive interpretations of the benthic population dynamics can be accomplished.

TABLE A-2. HEAVY METAL CONCENTRATIONS (PPM) IN MODIOLUS MODIOLUS FROM DRUNKARD'S LEDGE DEPLOYED AT ROCKLAND DISPOSAL SITE (NORTHERN NEW ENGLAND).

DATE	LOCATION		CD	CR	CU	HG	PB	ZN	FE
8-19-77	DRUNKARD'S LEDGE	\bar{x}	16.36	1.76	48.95	0.775	19.01	373	237
		S.D.	4.56	0.39	10.83	0.143	3.80	79	23
5-12-78		\bar{x}	12.04	1.59	25.14	0.529	8.35	399	285
		S.D.	1.94	0.27	4.99	0.078	3.74	262	27
8-7-78		\bar{x}	22.51	1.22	38.40	0.755	8.37	401	154
		S.D.	4.67	0.18	1.34	0.177	1.50	56	23
8-7-78	ROCKLAND	\bar{x}	16.50	1.25	36.35	0.237	12.87	346	221
		S.D.	3.37	0.31	7.63	0.056	5.63	116	41

TABLE A-3

DAMOS BENTHOS - TABLE OF NUMERIC DENSITY DATA

STATION ROCKLAND, MAINE		DATE 12 DECEMBER 1977								
PREDOMINANT SPECIES	DREDGE 1	NUMBER 2	TOTAL	MEAN	STD DEVIATION	COEFF. OF DISPERSION	95 PERCENT CONF. LIMITS OF MEAN	NUMERIC RANK	% OF TOTAL	CUMULATIVE % OF TOTAL
1. <i>Nucula proxima</i>	736	288	1024	512.0	316.8	196.0	----	1	93.9	93.9
2. <i>Nephtys incisa</i>	13	3	16	8	7.1	6.3	----	2	1.5	95.4
3.										
4.										
5.										
6.										
7.										
8.										
9.										
10.										
11.										
12.										
13.										
14.										
15.										
16.										
17.										
18.										
TOTAL	749	291	1040	520.0	323.9	201.7	----			
TOTAL NO. OF SPP. PER DREDGE	16	10	20	13.0	4.2		----			
SPECIES DIVERSITY (H')	0.41	0.27	0.68	0.34	0.10					
EQUITABILITY (J')	0.15	0.12	0.27	0.14	0.02					

TOTAL NO. OF INDIVIDUALS THIS STN = 1091

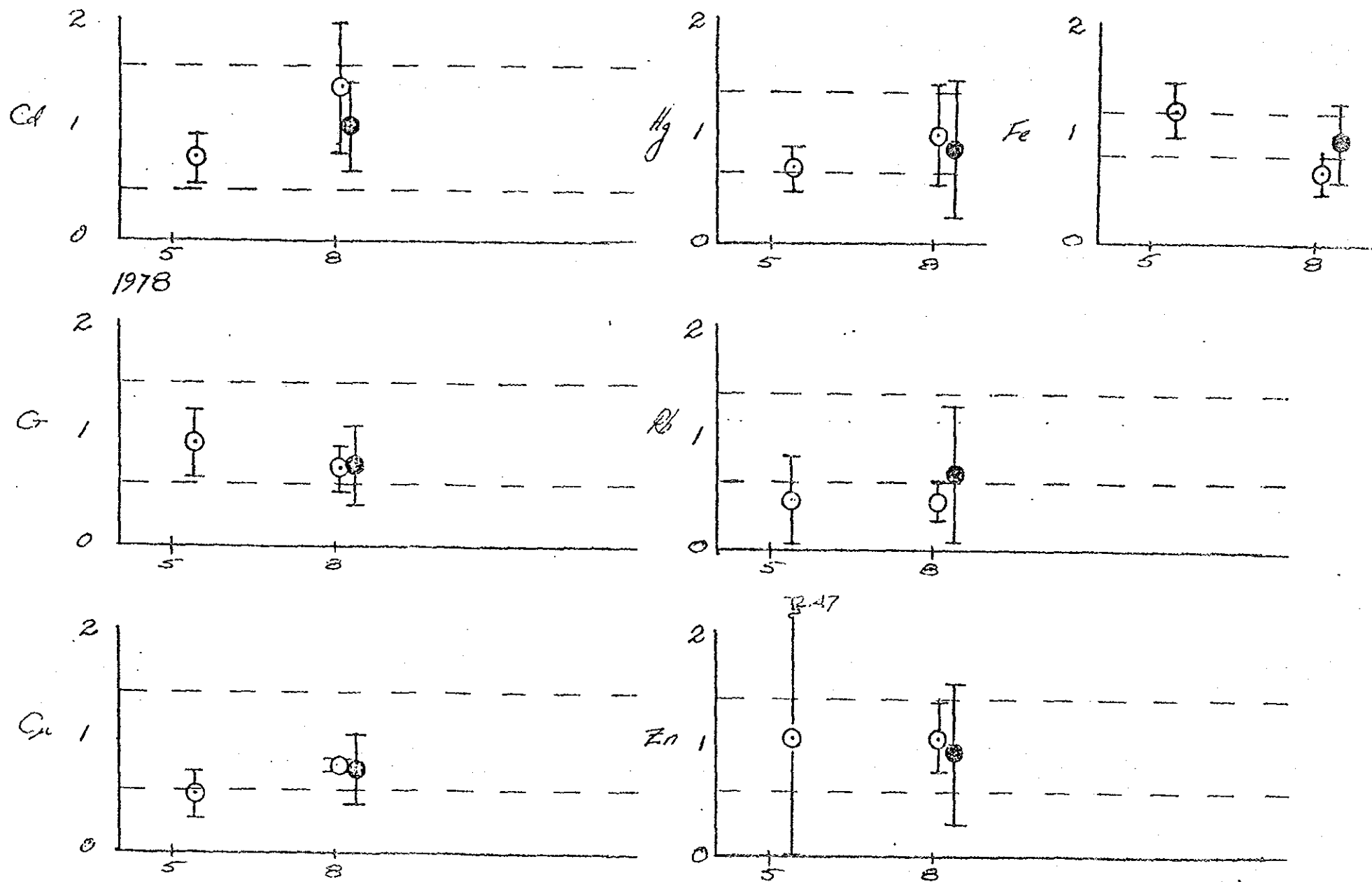

Figure A-4. Temporal variation in the ratios of heavy metals in *Modiolus modiolus* Drunkard's Ledge (O) deployed at Rockland (●) disposal site. Broken lines depict the 95% confidence limits of the baseline data.

Fisheries

A chart of the distribution of fisheries in the vicinity of the Rockland disposal site is presented in Figure A-5. There are four major fisheries in this area as discussed below:

1. Shrimp. Before the recent decline in catches (1973-1977) and subsequent closure of the fishery, shrimp were caught by at least one vessel towing at 55-75 meters on a course skirting the western edge of the dump site. This vessel fished throughout the period in which spoil from Rockland was dumped. No decrease in catch was detected, although sediments identifiable as spoil were brought up on the net on several occasions.

An unusual aspect of the catch in West Penobscot Bay is that in addition to the egg bearing females caught in January-March a population remained in the deeper holes through the summer. This population was mainly northern shrimp (Pandalus borealis), but also included a smaller competing species (P. montagui) (G. Stevenson; Rockport, Maine).

If the shrimp fishery is reopened there will be renewed interest in the muddy bottoms of this area. Larger lobster boats from all the surrounding ports are potential winter shrimp draggers.

2. Lobsters and Crabs. The important summer lobster fishery is carried out in shallow water, often less than 20 meters. The nearest shallow water is several miles northeast of the dump site.

In the fall and spring lobsters are found in deeper water. There is less fishery effort at these times because of the need for special rigging.

The strong currents and wind exposure in the dump site area limits the effort further. A lobsterman who fishes at these times estimated that he did not get closer than two miles to the disposal site. One other lobsterman probably also gets this close.

Lobsters are not caught in this part of Penobscot Bay between December and April. They either bury or move out. In 1977 the catch ended in November. When lobstering falls off, crabs (Cancer borealis) can be caught at 40-55 meters on muddy bottoms. Although crabs are caught in lobster pots, catches are improved by use of special traps and fresh bait. Most of the crabbing near the dump site is done by two vessels.

In the fall, pots are dense on a shoal just north of the entrance channel to Rockport. During the dredging a tow boat left the channel and destroyed some of this gear. It has been reported that the dredging company paid for the damage. Gear destruction may be the greatest potential threat from dredging in this area, but also easily avoided.

3. Sea scallops. Scallops (Argopecten gibbas) were dragged in Penobscot Bay as late as the 1940's and 1950's. They are now rare throughout Maine. Patches of scallops are not limited to any bottom type and could occur in the dump site area. Scallop dragging gear is heavy and would displace soft spoil.

4. Finfish. There is virtually no commercial finfishing in this portion of the Bay. Productive fishing grounds are found outside the Bay. Recreational bottom fishing is probably rare in this deep and exposed area.

In conclusion it can be stated that the Rockland disposal site is well placed to reduce potential effects on fisheries. One fisherman stated that cables recently placed in the area will cause more difficulty to the shrimp and scallop fishery than spoil will.